

ASSEMBLY INSTRUCTION

COFFEE TABLE

1-1x

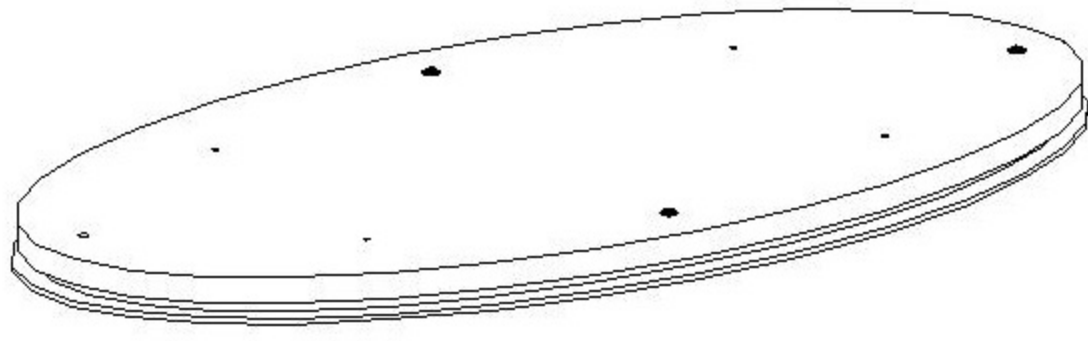

2-1x

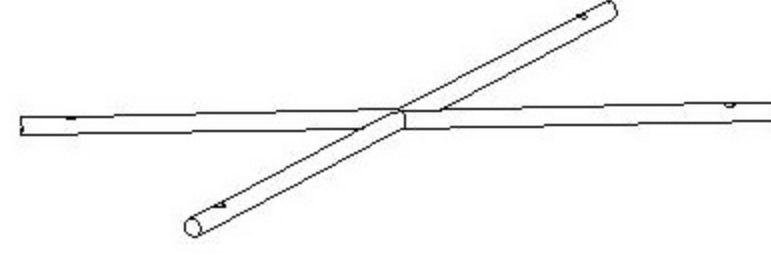

3-4x



A-4x

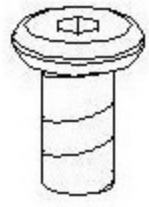

B-4x

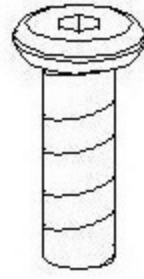

C-8x

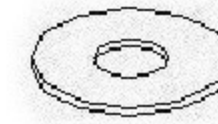

D-1x

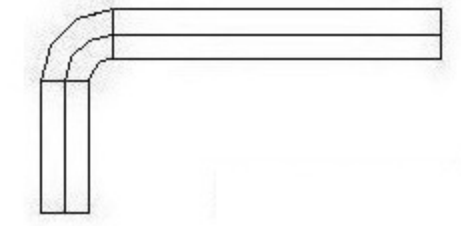

Step:1

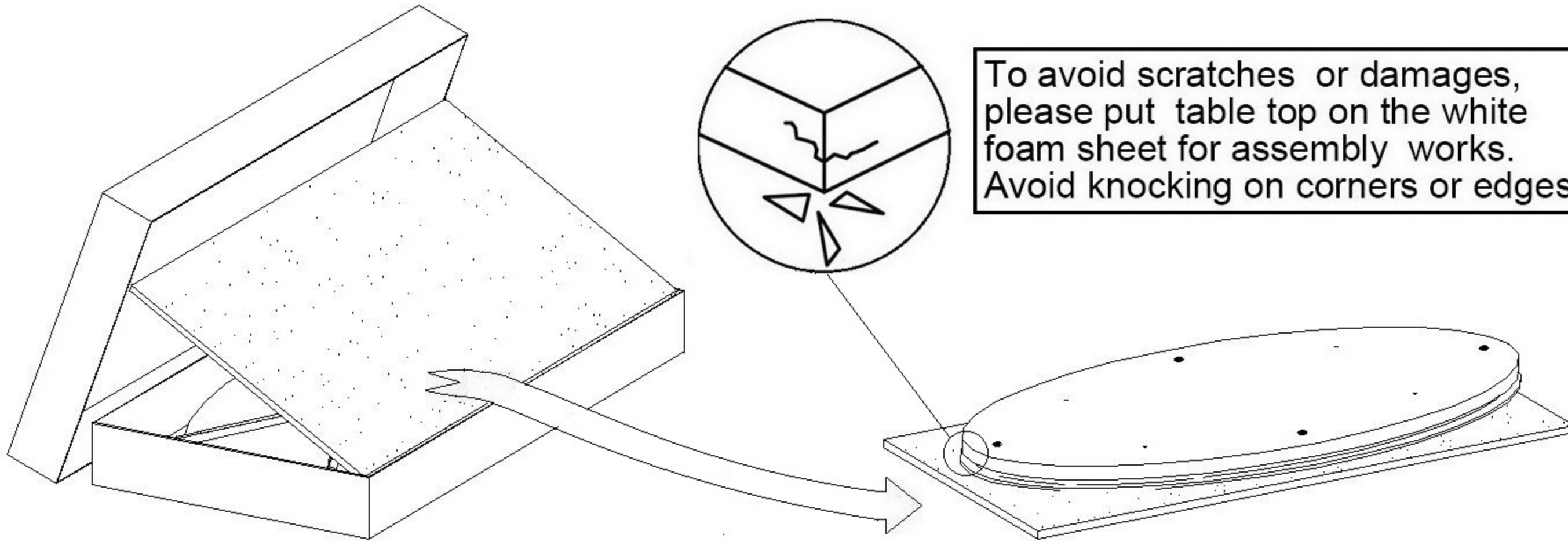

To avoid scratches or damages, please put table top on the white foam sheet for assembly works. Avoid knocking on corners or edges.

Step:2

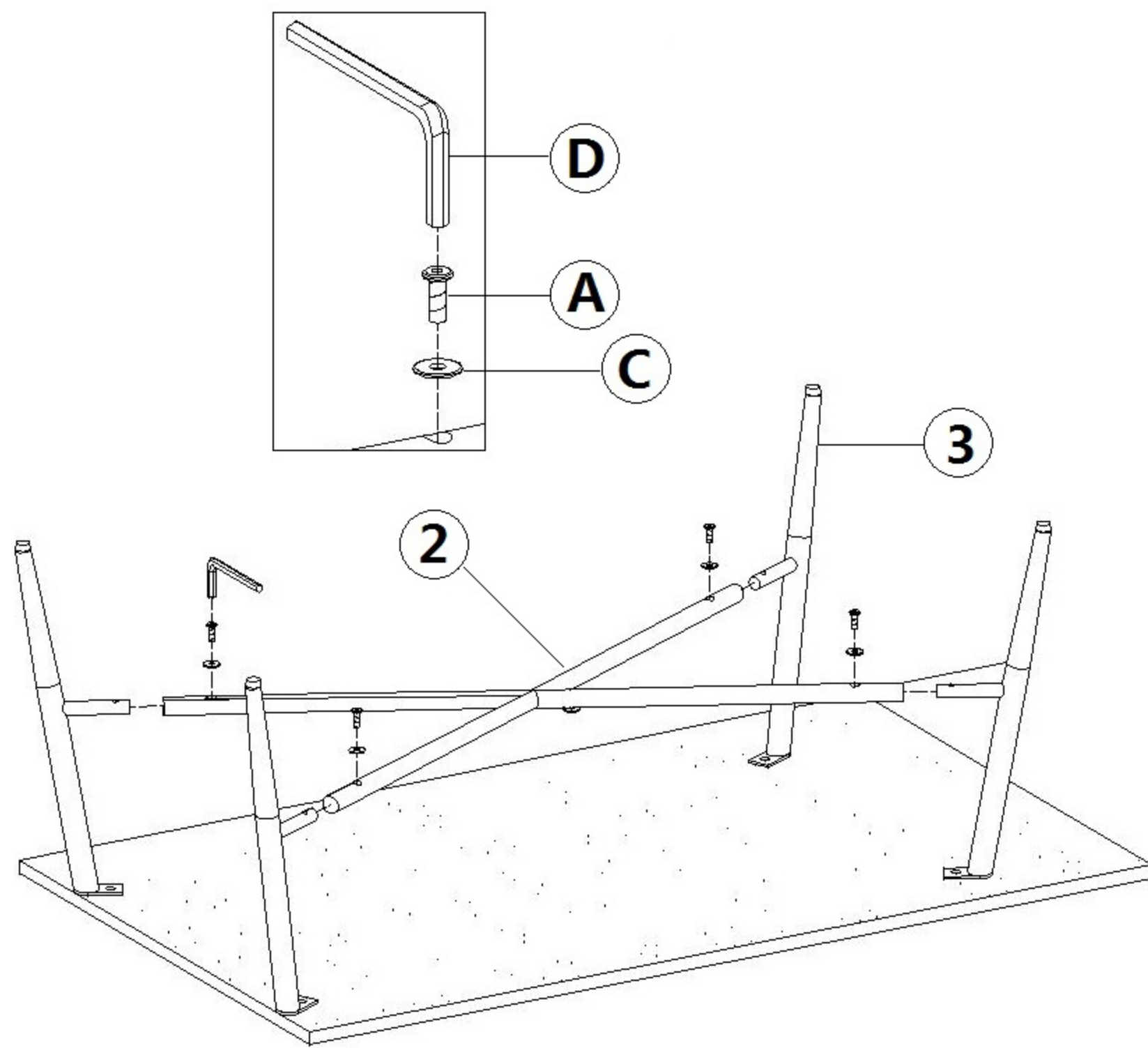

Step:3

Please keep all screws loose and tighten TOGETHER after all parts are assembled to the correct positions.

