

# ASSEMBLY INSTRUCTION

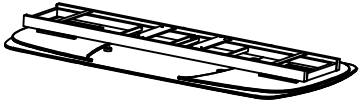

(A) x1

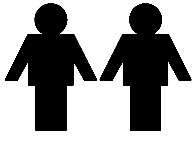

(B) x2



(C) x2



M8x20mm

(1) x8



M8

(2) x8

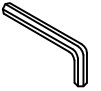

5#

(3) x1



M8x12mm

(4) x8



13#

(5) x1

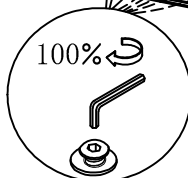
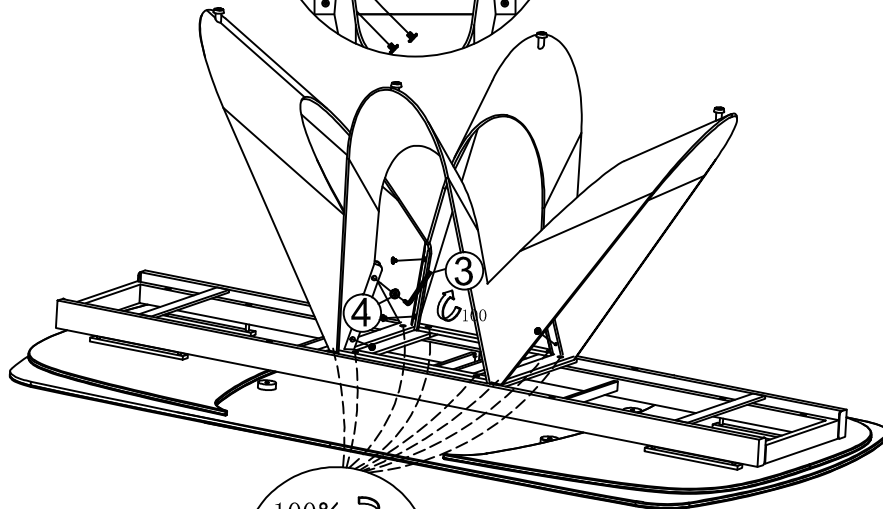
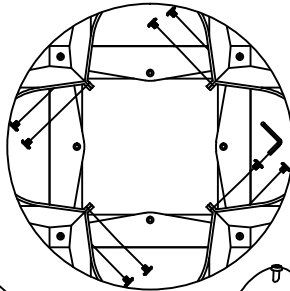
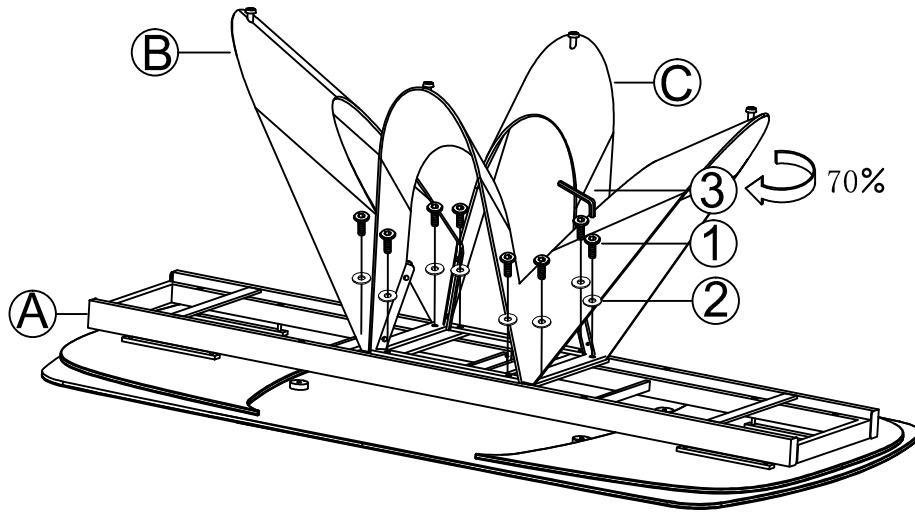

# ASSEMBLY INSTRUCTION

