

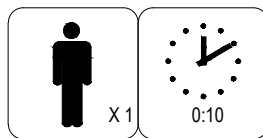

ASSEMBLY INSTRUCTIONS

DINING CHAIR MODEL#: UDC23017

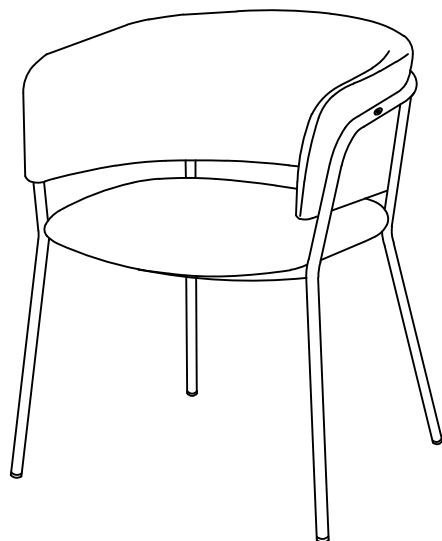
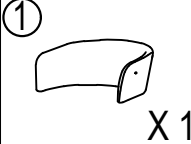
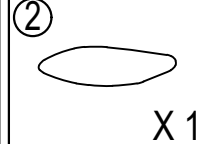

 ① X 1	 ② X 1	 ③ X 1	
 A M6*16 X 4	 B M6*30 X 2	 C X 4	 D X 1

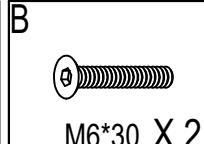
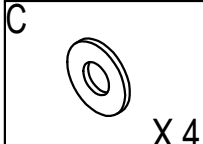
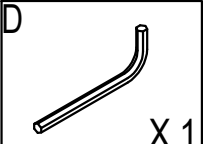
1

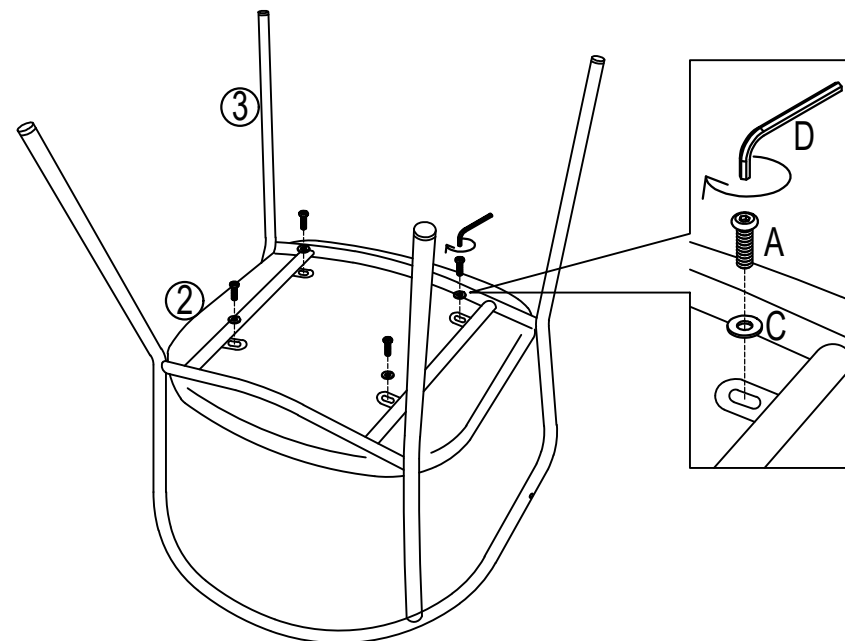

2

