

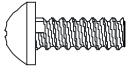

# Assembly Instruction

1*1		A*4+1EXT	 M6*16MM
2*1		G*1	 M4

## STEP 1

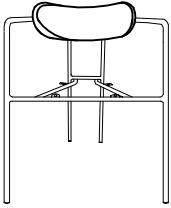

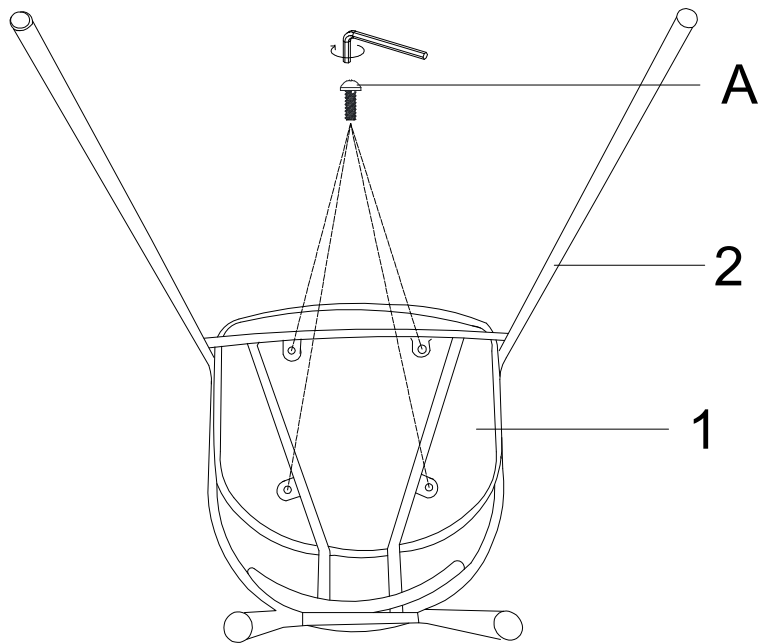
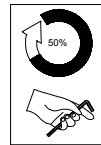
## STEP 2

