

ASSEMBLY INSTRUCTIONS

DINING CHAIR MODEL#: UDC22009

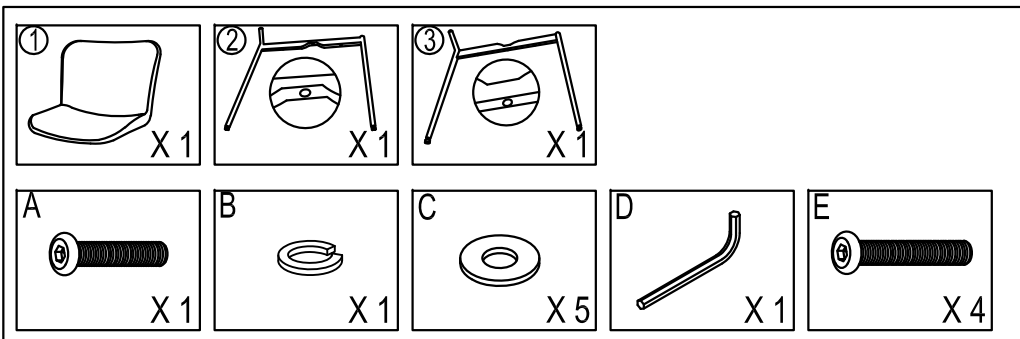

1

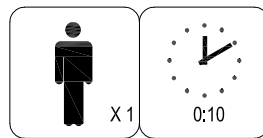
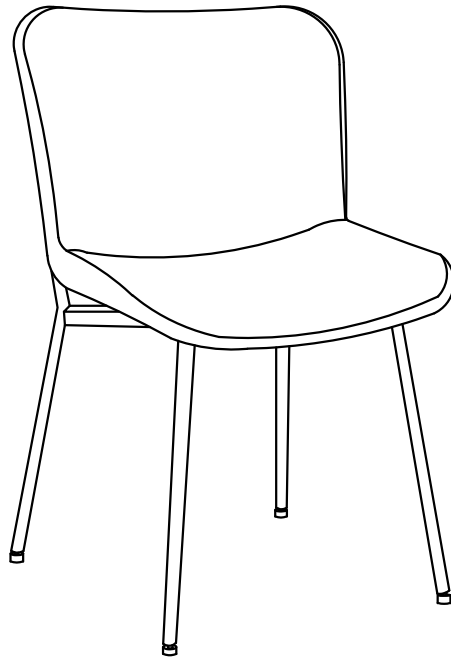
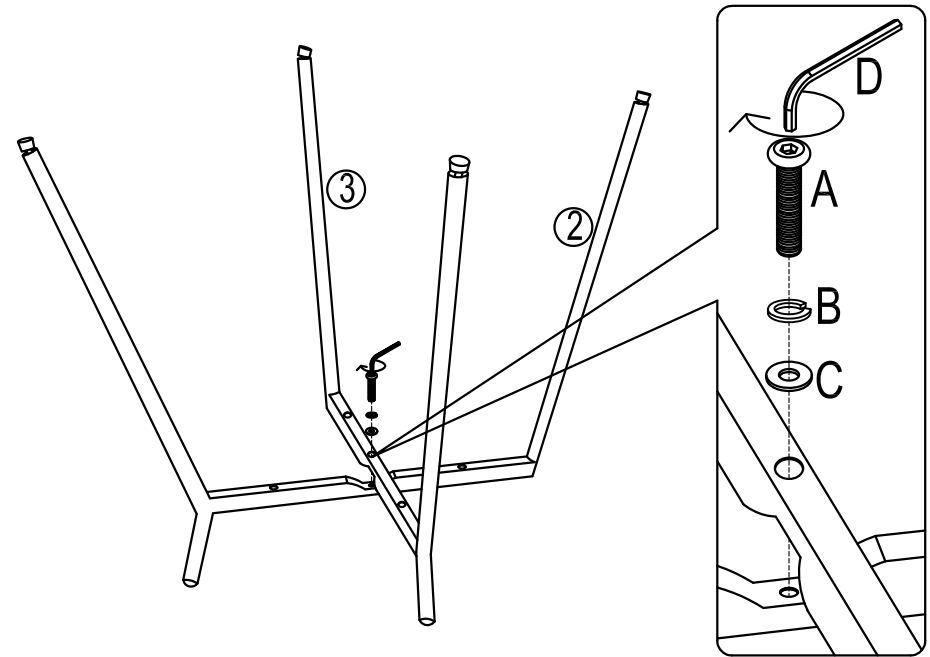

2

